

- (A) **2" Drainage manifold**
Colector drenaje 2"
- (B) **8" Inlet manifold - DIN 2576 Flanged**
Colector entrada 8" - Brida DIN 2576
- (C) **8" Outlet manifold - DIN 2576 Flanged**
Colector salida 8" - Brida DIN 2576

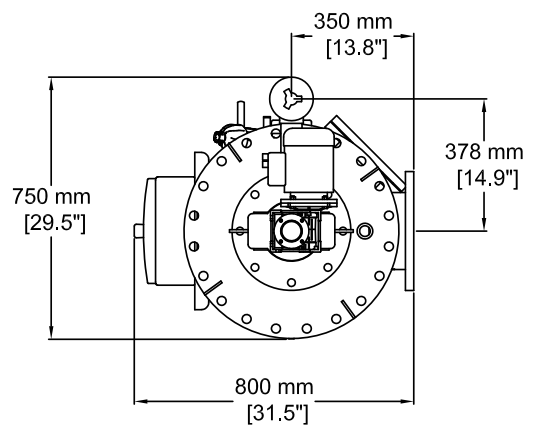

AZUD

SCALE
S/E
A4 FORMAT

AZUD LUXON LDB 9800/8

AZUD LUXON LDB 9800 M/8

RESPONS.: M. Martínez

REVISION: 05

UNITS: mm [in]

DATE: 13/04/2018