

- Ⓐ **2" Drainage manifold**  
Colector drenaje 2"
- Ⓑ **8" Inlet manifold - DIN 2576 Flanged**  
Colector entrada 8" - Brida DIN 2576
- Ⓒ **8" Outlet manifold - DIN 2576 Flanged**  
Colector salida 8" - Brida DIN 2576

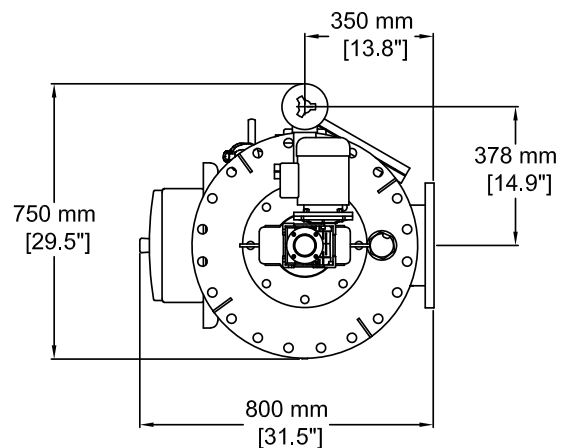

**AZUD**

SCALE  
S/E  
A4 FORMAT

**AZUD LUXON LDB 8000 S/8**

RESPONS.: M. Martínez

REVISION: 04

UNITS: mm [in]

DATE: 08/06/2017