

- (A) **2" Drainage manifold**
Colector drenaje 2"
- (B) **6" Inlet manifold - DIN 2576 Flanged**
Colector entrada 6" - Brida DIN 2576
- (C) **6" Outlet manifold - DIN 2576 Flanged**
Colector salida 6" - Brida DIN 2576

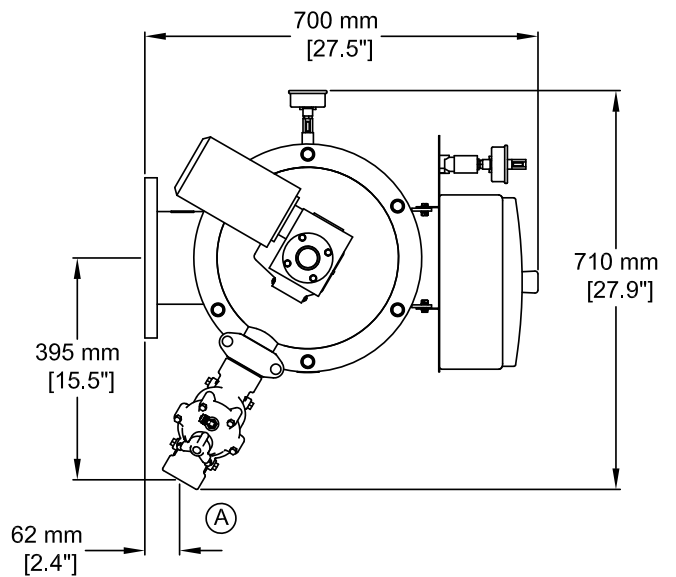

AZUD

SCALE
S/E
A4 FORMAT

AZUD LUXON LDB 4800/6
AZUD LUXON LDB 4800 M/6

RESPONS.: M. Martínez

REVISION: 04

UNITS: mm [in]

DATE: 13/04/2018