

- (A) **2" Drainage manifold**
Colector drenaje 2"
- (B) **10" Inlet manifold - DIN 2576 Flanged**
Colector entrada 10" - Brida DIN 2576
- (C) **10" Outlet manifold - DIN 2576 Flanged**
Colector salida 10" - Brida DIN 2576

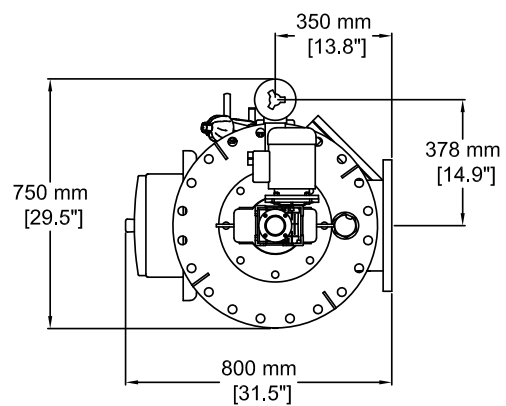

AZUD

SCALE
S/E
A4 FORMAT

AZUD LUXON LDB 13200 S/10

RESPONS.: M. Martínez

REVISION: 04

UNITS: mm [in]

DATE: 08/06/2017