

- Ⓐ **2" Drainage manifold**
Colector drenaje 2"
- Ⓑ **12" Inlet manifold - DIN 2576 Flanged**
Colector entrada 12" - Brida DIN 2576
- Ⓒ **12" Outlet manifold - DIN 2576 Flanged**
Colector salida 12" - Brida DIN 2576

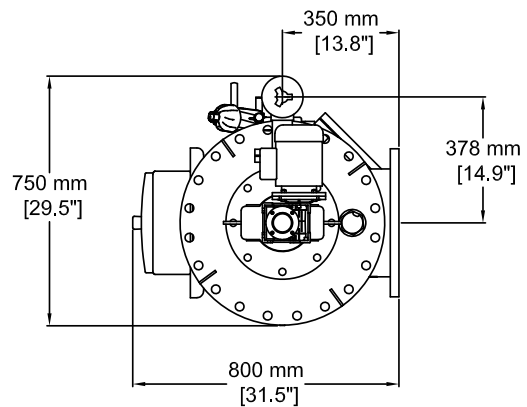

AZUD

SCALE
S/E
A4 FORMAT

AZUD LUXON LDB 12300/12
AZUD LUXON LDB 12300 M/12

RESPONS.: M. Martínez

REVISION: 05

UNITS: mm [in]

DATE: 13/04/2018